

Trench MOS Barrier Schottky Rectifier - 40Amp 45Volt

Features

- Plastic package has Underwriters Laboratory Flammability Classifications 94V-0
- High Junction Temperature Capability
- Low forward voltage, high current capability
- High surge capacity
- Low power loss, high efficiency
- Halogen-Free

Application

- AC/DC Switching Adaptor and other Switching Power Supply

Absolute maximum ratings

Symbol	Ratings	Unit	Conditions
IF(AV)	40	A	Average Forward Current
VRRM	45	V	Repetitive Peak Reverse Voltage
IFSM	300	A	Peak Forward Surge Current
VF	0.46	V	Forward Voltage Drop
Tj, Tstg	-65 to +150	°C	Operating and Storage Temperature

Electrical characteristics

Parameters	Symbol	Ratings		Conditions
		TYP.	MAX.	
Instantaneous Forward Voltage	VF			Per Leg at IF = 20A
		0.49V	0.52V	Tc = 25°C
		0.46V	0.49V	Tc = 125°C
Reverse Leakage Current	IR			Per Leg at VR = 45V
		0.2mA	0.5mA	Tc = 25°C
		30mA	50mA	Tc = 125°C
Typical Thermal Resistance, Junction to Case	R θ (j-c)	2.2 °C/W		Per Leg
		4.5 °C/W		TO-220AB ITO-220AB

Note : 1. Mounted on P.C.B with copper pad size 20mm x 30mm, thickness 1.5mm

December 2018 / Rev.7.2

SBL40V45CTH/FCTH

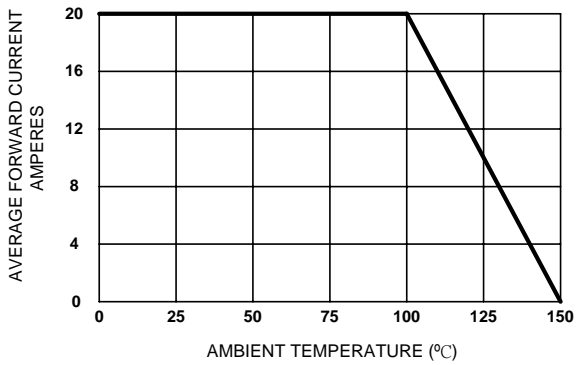

Figure 1. Forward Current Derating Curve

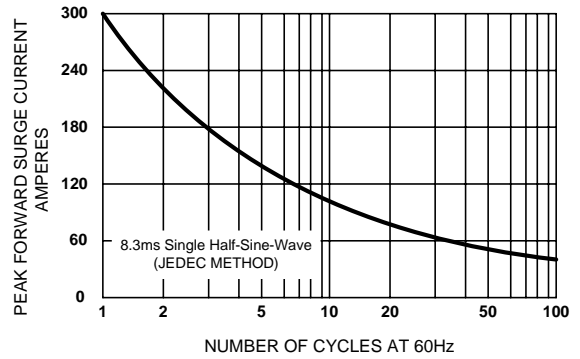

Figure 2. Maximum Non-repetitive Surge Current

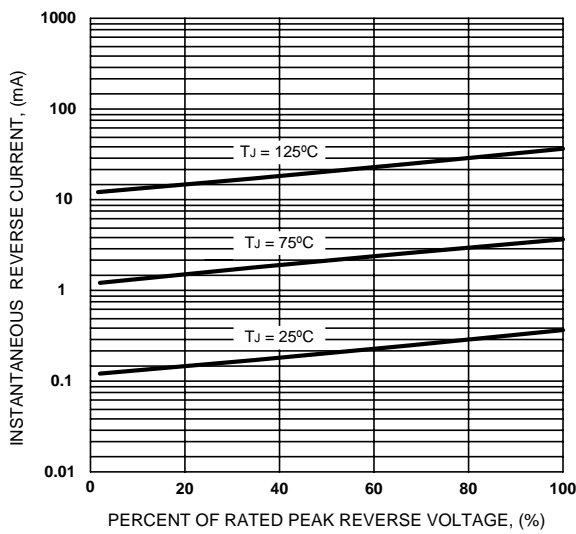

Figure 3. Typical Reverse Characteristics

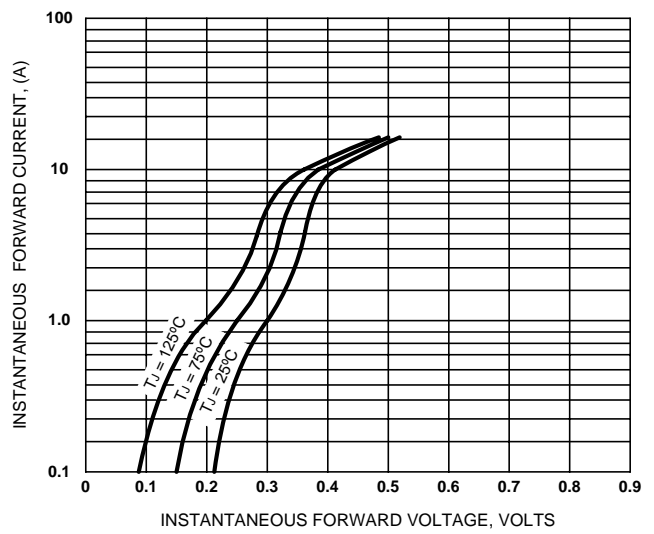

Figure 4. Typical Forward Characteristics

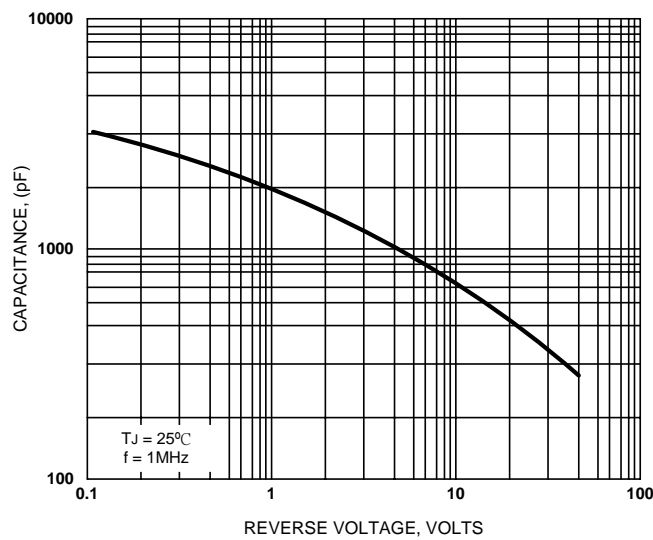
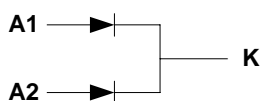
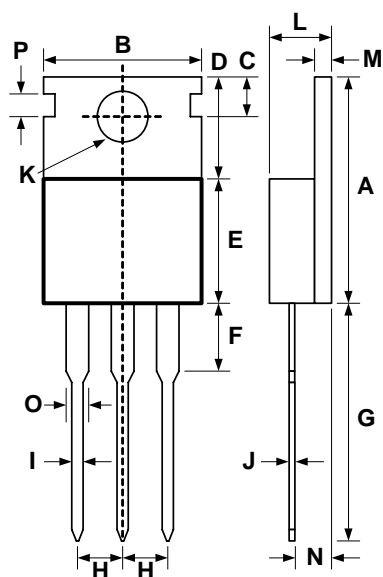

Figure 5. Typical Junction Capacitance

SBL40V45CTH

TO-220AB



DIM	DIMENSIONS				NOTE
	INCHES		MILLIMETERS		
	MIN	MAX	MIN	MAX	
A	.610	.630	15.5	16.00	
B	.390	.413	9.90	10.50	
C	.106	.126	2.70	3.20	
D	.228	.272	5.80	6.90	
E	.348	.372	8.85	9.45	
F	.102	.142	2.60	3.60	
G	.512	.551	13.00	14.00	
H	.093	.112	2.35	2.85	
I	.028	.037	0.70	0.95	
J	.016	.026	0.40	0.65	
K	.132	.152	3.35	3.85	
L	.169	.185	4.30	4.70	
M	.045	.057	1.15	1.45	
N	.089	.112	2.25	2.85	
O	.043	.055	1.10	1.40	
P	.055	.067	1.40	1.70	

SBL40V45FCTH

ITO-220AB

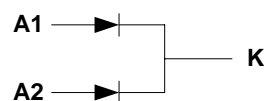
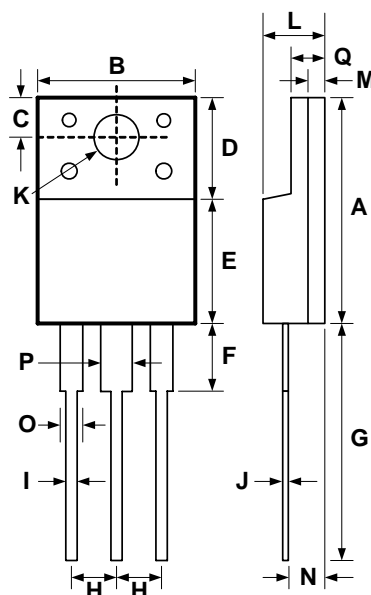

DIM	DIMENSIONS				NOTE
	INCHES		MILLIMETERS		
	MIN	MAX	MIN	MAX	
A	.581	.600	14.75	15.25	
B	.386	.410	9.80	10.40	
C	.102	.122	2.60	3.10	
D	.228	.272	5.80	6.90	
E	.315	.339	8.00	8.60	
F	.138	.177	3.50	4.50	
G	.512	.551	13.00	14.00	
H	.093	.112	2.35	2.85	
I	.020	.030	0.50	0.75	
J	.020	.030	0.50	0.75	
K	.120	.140	3.05	3.55	
L	.169	.185	4.30	4.70	
M	.039	.051	1.00	1.30	
N	.089	.112	2.25	2.85	
O	.043	.055	1.10	1.40	
P	.059	.071	1.50	1.80	
Q	.114	.130	2.90	3.30	

IMPORTANT NOTICE:

Sirect and Sirectsemi are registered trademarks of Sirect Semiconductor Incorporated. Sirect reserved the right to make changes to this document and its products and specifications at any time without notice. Customers should obtain and confirm the latest product information and specifications before final design, purchase and use.

Products described herein may be covered by one or more United States, China, Taiwan or foreign patents pending.

Sirect products are not authorized for use as critical components in life support devices or system without express written approval of Sirect.

Sirect Semiconductor Incorporated does not warrant or accept any liability whatsoever in respect of any products purchased through unauthorized sales channel. Should customers purchase or use Sirect products for any unintended or unauthorized application, customers shall indemnify and hold Sirect and its representatives harmless against all claims, damages, expenses, and attorney fees arising out of, directly or indirectly, any claim of personal injury or death associated with such unintended or unauthorized application.

© Sirect Semiconductor Incorporated